



Operation Manual

HealthWay 1200SC

COMMERCIAL AIR
PURIFICATION SYSTEM

 HealthWay®

Table of Contents

Limited Warranty	4
Safety Precautions	5
Receiving and Storage.....	5
Receiving	
Storage	
System Overview	6
Unit Description	
Component Description	
Installation Procedures.....	7-9
Power Requirements	
Location Determination	
Standard Inlet / Return Duct Connection	
Standard Supply (Outlet) Duct Connection	
Electrical Connection	
Installing Standalone Unit	
System Operation	10
Turn On Unit	
Turn Off Unit	
Maintenance	11-13
Prefilter Replacement	
V-Bank Main Filter Replacement	
Cleaning the Unit	
Parts List	
Troubleshooting	14
System Schematic	15



Part Number: #10057

Copyright: © 2020 All rights reserved.

Address: HealthWay, Inc.
3420 Maple Ave.
Pulaski, NY 13142

Phone No: 315-298-2904
1-800-843-3860

Email: info@Healthway.com

Limited Warranty

HealthWay offers a 5 Year Limited Warranty. 5 Years on motor and blower and 1 year on electronic components. A return authorization must be obtained before any product is shipped to the manufacturer for warranty repair and all transportation charges must be prepaid all work must be performed by an HealthWay authorized technician. The sole responsibility of HealthWay under this Limited Warranty is, at its sole discretion, to either repair or replace a duly registered product (or defective part thereof) with the same comparable model within a reasonable period of time, subject to the following exclusions, limitations, statutory rights, and warranty claim procedures. This Limited Warranty is exclusive, and HealthWay expressly disclaims all other or additional warranties, whether written or oral, expressed or implied, including, but not limited to, warranties of merchantability, workmanship, or fitness for a particular purpose.

EXCLUSIONS

- A. This Limited Warranty does not apply, or is void, as to any product or part damaged by (1) accident, misuse, abuse, or lack of reasonable care or normal maintenance; (2) installation or operation under conditions other than those recommended by HealthWay; (3) subsection of the product to any but the specified voltage; (4) servicing or disassembly by unauthorized personnel; (5) defacing the serial number; or (6) modifying the original factory assembled unit in any way.
- B. THIS LIMITED WARRANTY DOES NOT APPLY TO SHIPPING CHARGES FOR PRODUCT SHIPPED TO OR FROM THE FACTORY OR DESIGNATED SERVICE CENTER IN CONNECTION WITH WARRANTY CLAIMS NOR DOES IT APPLY TO ANY DAMAGES OCCURRING DURING SUCH SHIPMENT.
- C. This Limited Warranty does not apply to labor for installation, removal, re-installation, and/or travel or shipping expenses and related expenses.

This Limited Warranty does not apply to replaceable filters.

LIMITATIONS

HealthWay shall not be liable for property, incidental, and/or consequential damages of any kind and, unless otherwise prescribed by applicable state law, HealthWay shall not be liable for personal injury resulting from malfunctions, defects, misuse, improper operation or installation, or alteration of a HealthWay product or any part thereof. The exclusive remedy for a breach of this Limited Warranty is the repair or replacement of the defective product. In no case, shall liability under any other remedy prescribed by law exceed the purchase price of the product.

WARRANTY CLAIM PROCEDURE

This information is provided as a guide regarding warranty claim procedures for HealthWay, Inc air purification systems.

1. Determine model number from the label on the unit.
2. For technical support, warranty information, warranty parts or replacement parts, call HealthWay at 315-298-2904 or 1-800-843-3860 from 8:00 AM-5:00 PM EST a HealthWay representative will help you troubleshoot and diagnose the problem. Warranty matters involving products sold through a manufacturer representative should be directed to the appropriate representative.
3. Important: Do NOT return anything without a Return Authorization.
4. All returned parts are quality tested. If the returned part is found not to be defective, you may be invoiced for the new part.

Safety Precautions

SAFETY PRECAUTIONS

Personnel, who will operate this system, or those who will perform maintenance thereon, must be given all manuals and other instructions regarding safe operation of the filtration system.

This manual contains general recommendations, but specific requirements may apply to individual installations. Such requirements are outlined in federal, state, and local codes. Compliance with applicable codes and strict adherence to these installation instructions are the sole responsibility of the user.



This symbol will be used throughout this manual to indicate safety checkpoints. Failure to heed these warnings and notices may result in damage to the unit and/or injury to personnel.

Receiving and Storage



Must install the Prefilter and V-Bank Main Filter before turning on the unit.

RECEIVING

Your unit has been carefully packed to avoid damage in shipping and storage. Equipment is prepared for shipment in accordance with the Uniform Freight Classification. It is thoroughly inspected at the factory and barring damage in transit, should be received in good condition.

When a freight carrier signs the HealthWay bill of lading, the carrier accepts the responsibility for any subsequent shortages or damage evident or concealed. Inspection by the carrier of damage evident or concealed must be requested. Evident shortage or damage should be noted on the carrier's delivery document before signature of acceptance. Claims must be made against the carrier by the purchaser.

Filtration systems are shipped as fully assembled filter units.

STORAGE

Store it in a dry place protected against moisture, dust, physical damage, weather, corrosion and excessive heat/cold.

System Overview

UNIT DESCRIPTION

The Air Cleaning System is a high performance system that utilizes patented award-winning Disinfecting Filtration System technology. DFS technology electrically converts a low pressure drop filter to high efficiency while retaining the low pressure drop and longer life advantages of the base filter material. This technology has also been shown to inhibit bacteria growth on the filter.

The Electrical Components are located in an enclosed electrical box inside the unit.

The 1200SC DFS Air Cleaning System is available in the following models:

1200SC	Height		Width		Depth		Weight	
	16.5in	420mm	25.5in	648mm	38in	965mm	118lbs	54kg
22in (w/casters)	559mm (w/casters)							

COMPONENT DESCRIPTION

The 1200SC DFS Air Cleaning System integrates the system components into a single, self-contained unit: the Prefilter, V-Bank Main Filter and the High Energy Grid are accessible from the side service door. The fan inlet screen is located in front of the blower and provides protection from loose items being drawn into the fan and thus damaging the unit and the internal components.

Electrical controls are located on the top of the unit. It can also be installed remotely per request. It consists of the Main Power ON-OFF switch with a Blue LED to indicate High Voltage Power Supply power status, Blower Speed Status and Blower Speed Control Switch.

Replacement Filters	Efficiency	Replacement Period*
Prefilter	MERV-8 (35% Efficiency)	1-2 times per year
DFS V-Bank Main Filter	99.99% Efficient (down to .007 microns)	once a year



Please confirm your model number and follow the instructions for that model. The electrical power requirements for each individual unit are on the data plate label. These requirements supersede all other inferences to power requirements.

Installation Procedures

POWER REQUIREMENT

The power requirements are as follows:

*Electrical disconnects may also be required - check local electrical codes

Model	Power Requirement			FLA	Power Usage Max Start-up
	V	Hz	Phase	AMPS	WATTS
1200SC	120	60	1	3.47	416
1200SC	220	50	1	1.75	406

LOCATION DETERMINATION

The filtration system location should be carefully planned with consideration given to the ease of access to the filter service doors. Casters and power cord are optional for standalone 1200SC unit.

The location and operation of the unit shall follow state /local code for installation of electrical devices.

If the filter unit is to be located on a platform or the floor it should be located 6" off the ground to facilitate access to the filter access door.

The inlet duct also must have at least 8" of straight duct before any bends are made.

There should be no use or spillage of powdered products, aerosols, sprays, or mists near the 1200SC system.

Do not install the filtration system in an exterior environment, unless it is specifically made for exterior installations. Standard units are for indoor use only. The wiring or strapping must be at least 350-pound test weight.



Do not operate unit using an extension cord.

Installation Procedures

STANDARD INLET / RETURN DUCT CONNECTION

A 14.5" x 20.5" (out flanged) duct may be connected to the unit using the instructions below, refer to (fig-A)*

Align duct with 12, threaded 10-32 holes on filter inlet panel.

Secure with 12, #10-32 x 3/4" machine screws (G-4) being careful not to damage gasket. Do not use screws longer than 3/4" as damage to the filter unit may occur.

All ductwork must be kept clean and be properly sealed.

STANDARD SUPPLY (OUTLET) DUCT CONNECTION

A 14.5" x 20.5" (out flanged) duct may be connected to the unit using the instructions below, refer to (fig-A)*:

Align duct with 12, threaded 10-32 holes on filter inlet panel.

Secure with 12, #10-32 x 3/4" machine screws (G-4) being careful not to damage gasket. Do not use screws longer than 3/4" as damage to the filter unit may occur.

All ductwork must be kept clean and be properly sealed.

Inlet(Return) / Outlet(Supply) Duct Connection

Fig A

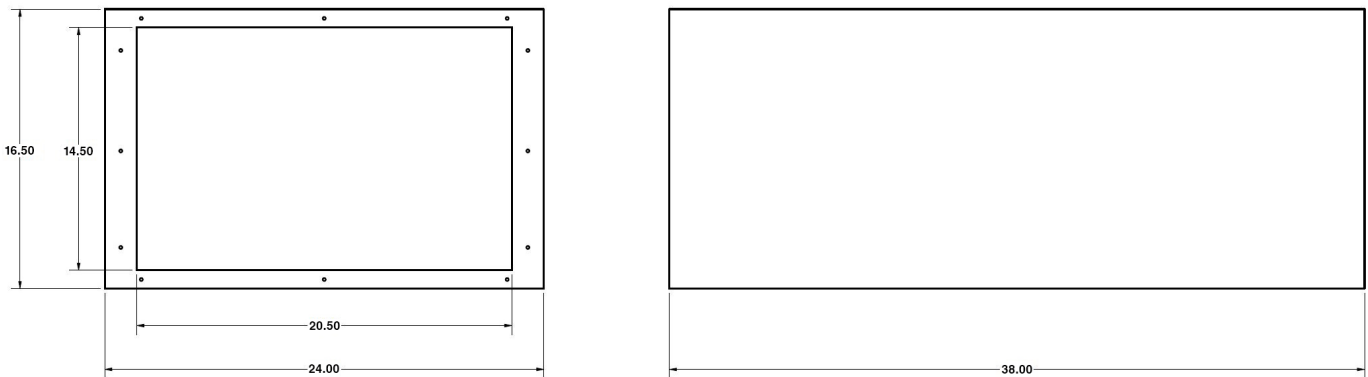

Installation Procedures

ELECTRICAL CONNECTION

If the 1200SC unit comes with power cord and casters as a standalone unit, inspect power cord for damage before plugging in. The outlet must be grounded. For installation, please refer to following steps:

1. Remove the filter access door on the side of the unit, and remove the electrical access door.
2. Remove the two electrical knock-out plugs (bottom and top) that are not being used. A separate electrical disconnect may be required by local electrical code.
3. Connect the proper size wires to terminals (L1) (L2)* (L3)* N (neutral)** and G (ground), check local electrical codes for wire sizing. These terminals are on Terminal Strip labeled "TS1".
4. Follow the directions included on the schematic for connections and wiring details.

INSTALLING STANDALONE UNIT

1. Remove all four casters.
2. Remove the filter access door on the side of the unit, and remove the electrical access door.
3. Remove power cord and top mounted speed control box.
4. Connect the proper size wires to terminals (L1) (L2)* (L3)* N (neutral)** and G (ground), check local electrical codes for wire sizing. These terminals are on Terminal Strip labeled "TS1".
5. Install speed control panel remotely.

* L2 and L3 exist only in 3 phase units. ** N (neutral) connection may not exist in all models.



All electrical connections must be done by a certified electrician, following the directions listed in this manual.



Check the model data plate on the front of the electrical box, which indicates all the electrical requirements for this unit.



Disconnect power to the unit before servicing.

System Operation

1. After mechanical and electrical connections are made, ensure the electrical supply connected matches the input voltage to the product label.
2. Remove the filter access door and manually spin the blower wheel to ensure that the blower wheel spins freely. If this is not the case adjust the motor mount until the blower spins freely and then proceed. Return and lock the filter access door.
3. Start the unit and set the speed to full and ensure the unit runs at full speed.
4. Balance the airflow by adjusting the speed of the blower until the desired air flow rate is achieved.



All electrical connections must be done by a certified electrician, following the directions listed in this manual.

TURN ON UNIT

Turn on the Main Switch on the remote-control panel. The Blue Light (DFS) should come on, indicating the power is on. (fig-B)

TURN OFF UNIT

To turn off the unit, simply turn off the Main Switch located on the remote-control panel.

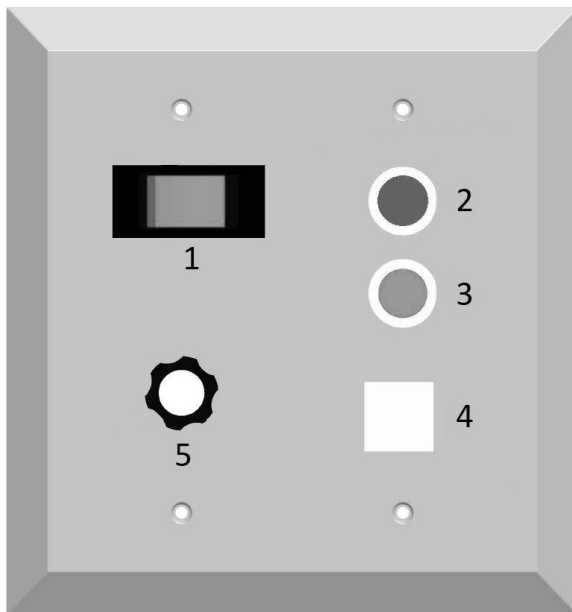

Fig-B

CONTROL PANEL

1. Main Switch
2. Blue Light (DFS)
3. Red Light (Replace filter)
4. Filter Test Switch
5. Fan Speed Regulator

Maintenance



When replacing filters use only HealthWay certified filters. HealthWay filters are designed for high voltage operation. Use of non-HealthWay filters can be hazardous to personnel and equipment voiding the warranty.

PREFILTER REPLACEMENT

Lock the (2) front wheels to secure the unit if the unit comes with casters (fig-1).

Remove the filter access door by unlocking two quarter-turn-latches (fig-2).

Filter access door removal may require a firm pull to release.

Slide Prefilter out of the filter channel (fig-3).

To install a new Prefilter, slide the new Prefilter into the channel in accordance with the direction of the air flow label (fig-3).

Ensure the Prefilter is firmly seated, unit will not turn on without installing Prefilter correctly.

Return the filter access door to the unit, (fig-4) threaded pin shall be positioned in between two plastic pads to activate safety switch. Failing to that will not turn on the unit.

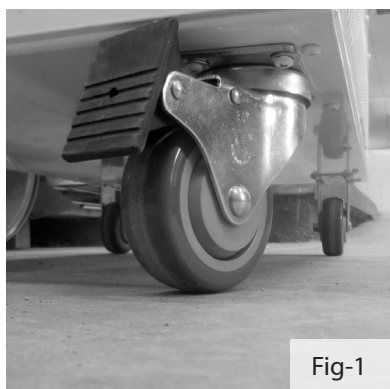

Fig-1

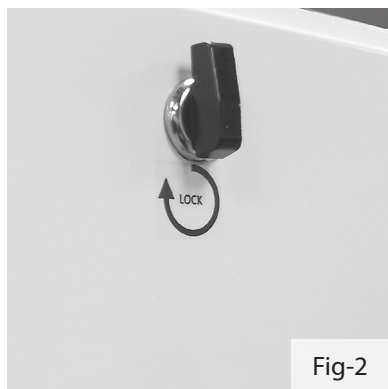

Fig-2

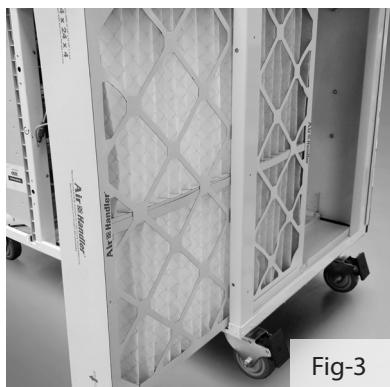

Fig-3



Fig-4

Maintenance



Always unplug the unit and wait a minimum of 30 seconds before touching the unit.

V-BANK MAIN FILTER REPLACEMENT

- Lock the (2) front wheels to secure the unit if the unit comes with casters (fig-1).
- Remove the filter access door by unlocking two quarter-turn-latches (fig-2 on page 10).
- Filter access door removal may require a firm pull to release.
- Disconnect the red wire lead from the multiplier (fig-5).
- Unlock V-bank filter with a flat screw driver or similar tools turning lock cylinder in accordance with labeled direction (fig-6).

Using a firm pull, remove the V-Bank Main Filter and High Energy Grid Assembly out of the filter access opening (fig-7).

Inspect and clean the inside of the unit.
Refer to page 13 for proper instructions.

Separate the High Energy Grid from the V-Bank Main Filter by turning and unlocking three panel clips (fig-8).

Replace the V Bank Main Filter (fig-9) and apply High Energy Grid to the new filter.

Secure the High Energy Grid to the new V Bank Main Filter by turning and locking three panel clips (fig-8).

Slide the V-Bank Main Filter and High Energy Grid Assembly back into the unit. Pay attention to the Flow Direction Arrow on the filter, the arrow should point towards the Supply/Outlet end of the unit.

Lock V-bank filter with a flat screw driver or similar tools turning lock cylinder in accordance with labeled direction (fig-6).

Reconnect the High Voltage Lead.

Before returning the door, ensure the Prefilter is firmly seated. The unit will not run if the Prefilter is not installed correctly.

Return the filter access door to the unit, (fig-10) threaded pin shall be positioned in between two plastic pads to activate safety switch. Failing to that will not turn on the unit.

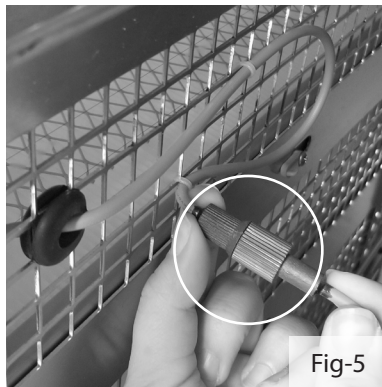

Fig-5

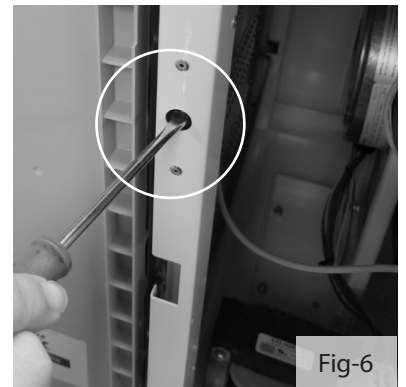

Fig-6

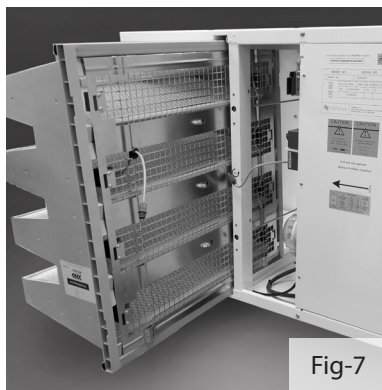

Fig-7

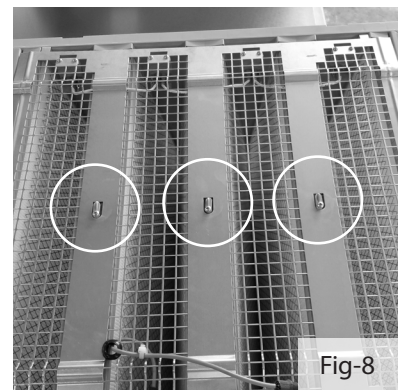

Fig-8

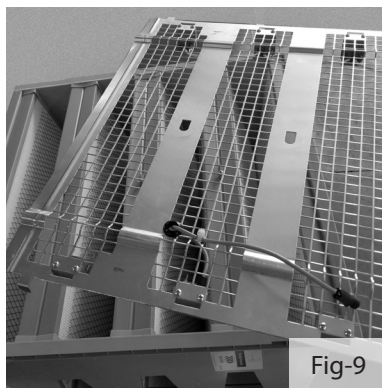

Fig-9



Fig-10

Maintenance

CLEANING THE UNIT

Depending on contamination level, this procedure should be conducted about once a year or during each filter change or if an electrical problem occurs.

Remove the V-Bank Main Filter and High Energy Grid Assembly
Refer to page 12 for proper instructions.

To clean the wires, use a lint free swab, either dry or moistened with denatured alcohol, clean along the length of each wire and spring clips.

Clean the inner surfaces of the High Energy Grid material using a lint cloth moistened with denatured alcohol.

Clean the High Energy Grid surface by vacuuming between the wires using a small vacuum attachment or by using a lint free cloth, either dry or moistened with denatured alcohol. Take care to avoid leaving large fibers snagged on the wires, control grid, or other components of the High Energy Grid.

Make sure that any contaminant that falls to the bottom of the filter unit is removed.

In extreme cases, it may be necessary to remove the wires from the springs attached at each end to the power distribution bars, thus allowing complete access to the inside of the High Energy Grid assembly for cleaning as previously described. It is recommended that the manufacturer be contacted for detailed instructions should this step appear necessary.

Vacuum the bottom of the filter seal plate section and of the filter unit to remove any particles dislodged during cleaning. Reinstall the High Energy Grid, V-Bank Main Filter and Filter Access Door as previously instructed.

Do not install the High Energy Grid to the V Bank Filter until wires are completely dry.

PARTS LIST

Order all parts by contacting: Phone No: 315-298-2904 • 1-800-843-3860
 Fax No: 315-298-6992
 Email: info@healthway.com

Description	Part Number
Prefilter	FT-1200-4
V-Bank Main Filter	950/1200_MainFilter
High Energy Grid	950P/1200_HEGrid
Multiplier	NZ-025
Blower	EC-026*
120v Power Supply	2010
Interlock Switch Single-Pole	2069
High Energy Wire	WH502
Tungsten wire	WH611

* Please contact HealthWay at 315-298-2904 or info@Healthway.com to confirm the replacement blower

Troubleshooting

For additional troubleshooting assistance refer to the DFS Troubleshooting Guide on the following page or contact HealthWay; Monday-Friday, 8am-5pm EST:

Phone No: 315-298-2904 • 1-800-843-3860
 Fax No: 315-298-6992
 Email: info@healthway.com



Service should only be done by a qualified factory trained technician.

Problem Description	Recommended Action
1. Blue LED (HVPS-1) is OFF - Fan is running	a. Turn off the unit at on/off switch located on the control pane, wait 60 seconds and turn the unit back on. If the fan motor does not run, continue to next step. b. Check the High Energy Grid for broken, loose or disconnected wires and debris. Refer to page 13 "CLEANING THE UNIT" to clean wire. If the problem persists then refer to the DFS Troubleshooting Guide. c. If the problem persists, then call number above for assistance.
2. Fan motor not running	a. Turn off the unit at on/off switch located on the control pane, wait 60 seconds and turn the unit back on. If the fan motor does not run, continue to next step. b. Check whether the unit is running on the required supply voltage and confirm the status of breakers and fuses. c. If problem persists, then check for disconnected wires or connectors inside the unit and its Electrical Box including all low voltage control connections.
3. Blue LED (HVPS-1) is OFF - Fan is not running	a. Turn off the unit at on/off switch located on the control pane, wait 60 seconds and turn the unit back on. If blue light (DFS) does not stay lit/the fan motor does not run, continue to next step. b. Check whether the unit is running on the required supply voltage and confirm the status of breakers and fuses. c. If the problem persists, check the threaded pin located on access door. Threaded pin shall be positioned in between two plastic pads to activate safety switch.
4. Red LED	Hold the filter test switch for 30 seconds. If the red LED light turns on, it's time to change filter.

DFS TROUBLE SHOOTING

Probable cause: Faulty Voltage Multiplier. Faulty High Voltage Supply

Confirmation:

Step 1: Disconnect power to unit.

Step 2: Remove the filter access door on the side of the unit, and remove the electrical access door.

Step 3: Locate the Voltage Multiplier. The Voltage Multiplier is a gray, rectangular device with red and black wires at one end and a single red wire at the opposite end.

Step 4: Disconnect the red wire of the Voltage Multiplier from

the "J3" terminal of the High Voltage Power Supply (HVPS). Stay clear of this terminal while testing and Do Not attempt to reconnect the terminal with power applied to the unit.

Step 5: Reconnect power to the unit.

Step 6: Place the unit in "run" mode and observe the status of the High Voltage Power Supply Indicator Light (Blue LED).

Conclusion: If the blue LED light stays off with no Voltage Multiplier attached there is a fault in the High Voltage Power Supply. If the blue LED light is on with no Voltage Multiplier attached there is a fault in the Voltage Multiplier. Contact us for replacement part.

1200SC-2-120/230-1 Electrical Schematic

120v / 230v Single Phase

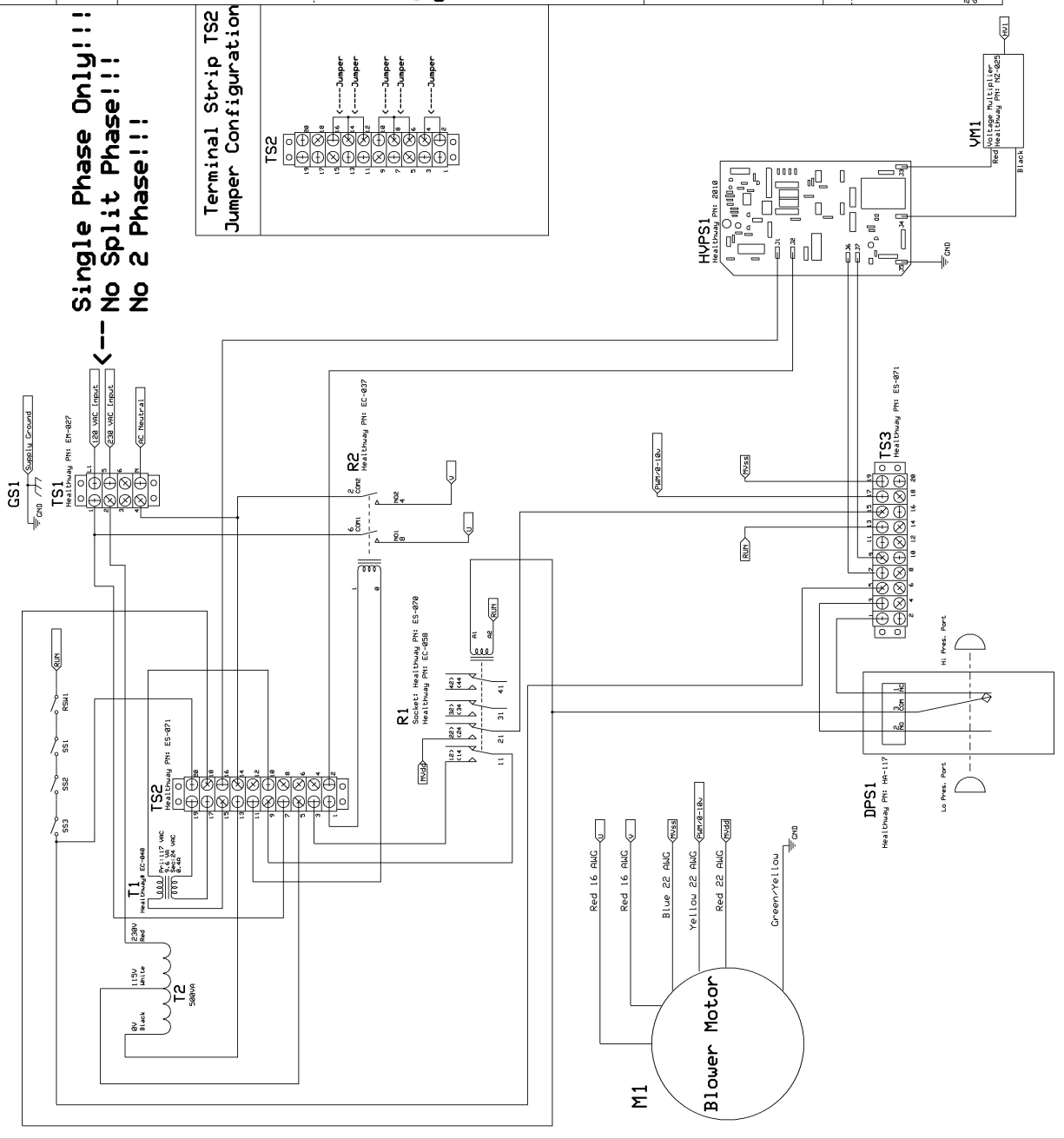

Single Phase Only!!!
No Split Phase!!!
No 2 Phase!!!

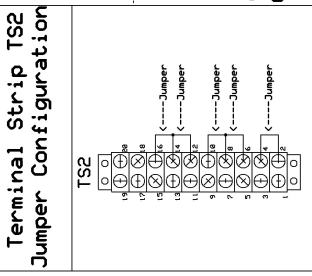

Control Wire Specs.

Use 24 AWG Stranded 300 VAC Min.
 For all control wiring

Control Connections SC Wired Remote

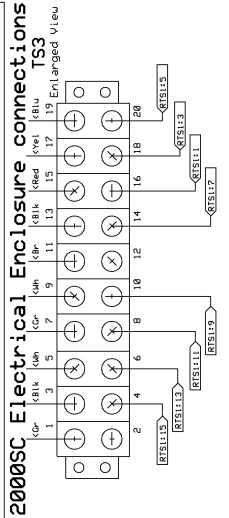

Remote "Wall" Control Connections

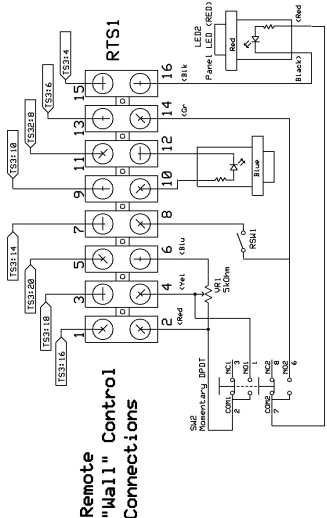

DDC, PLC, Building Management Control Inputs

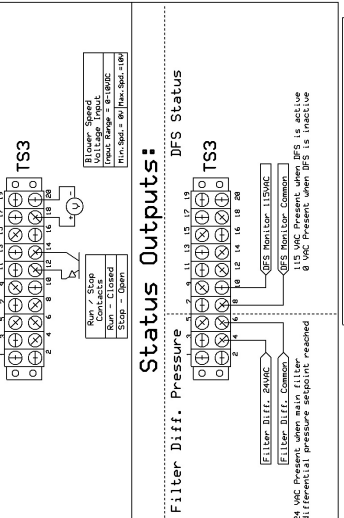

HealthWay Home Products Inc.
 1200SC-2-120/230-1
 Timothy Cusack Rev. 1.8 Electrical Schematic
 1/14/2008

healthway.com